

# ПРОФИЛЬНАЯ СИСТЕМА LITE'70

---

ТЕХНИЧЕСКАЯ ИНФОРМАЦИЯ  
ОПИСАНИЕ ПРОФИЛЕЙ

Профильные системы "МЕЛКЕ" изготавливаются методом коэкструзии с использованием вторичного сырья во внутреннем слое, который может отличаться от стандартного белого цвета внешнего слоя

# Рама 70мм / Арт.№3456

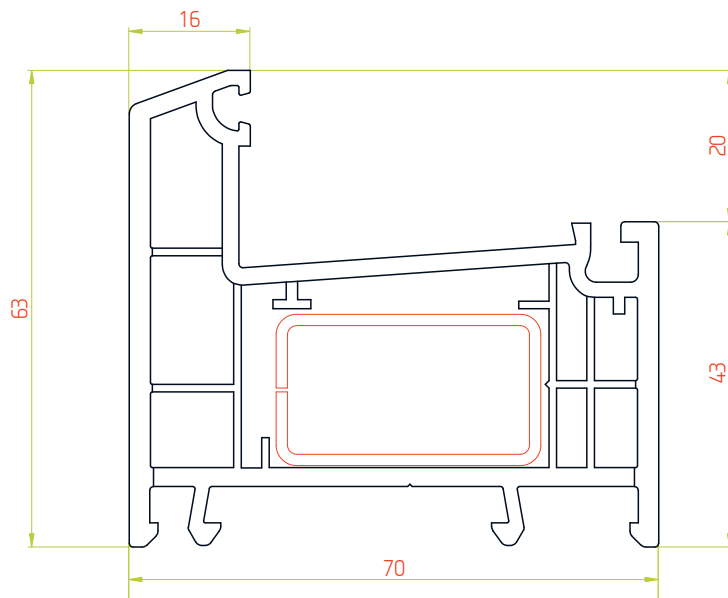

М 1:1

## Армирование

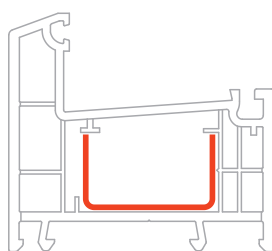

35x20мм

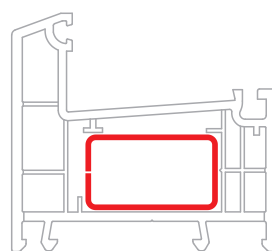

35x20мм

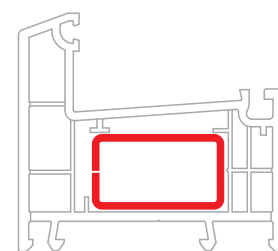

35x20мм



М 1:2

# Импост 70мм / Арт.№3109

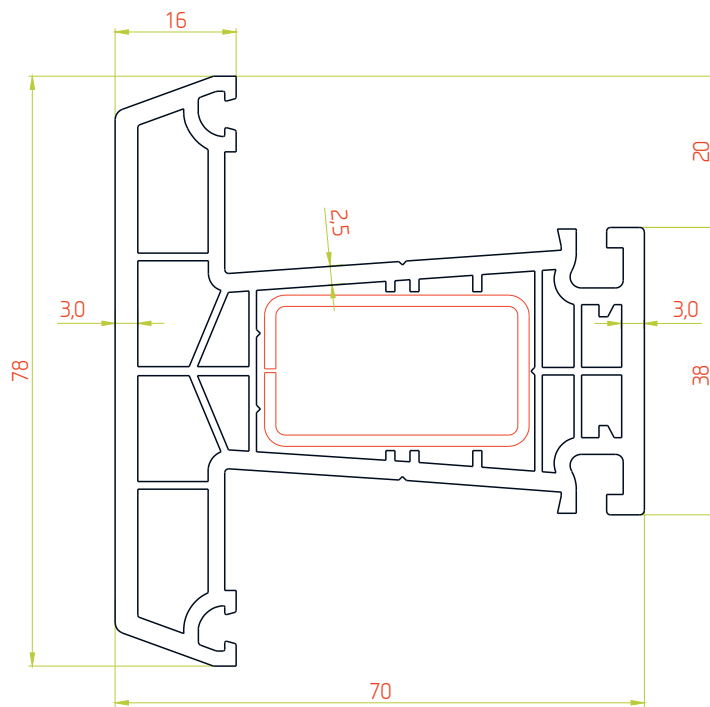

М 1:1

## Армирование

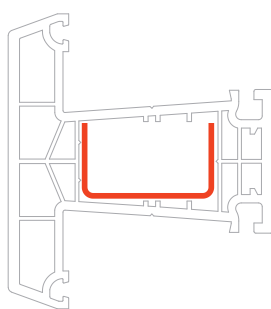

35x20мм

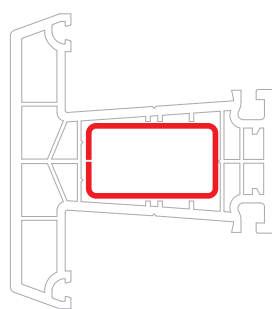
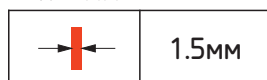

35x20мм

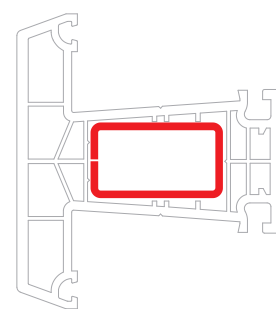

35x20мм



М 1:2

# Створка 70мм / Арт.№3457

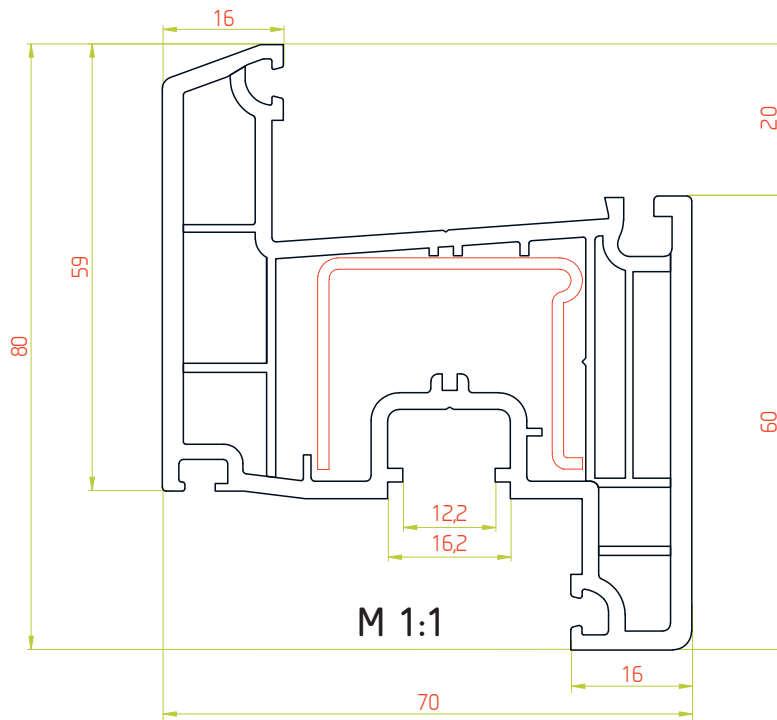

## Армирование

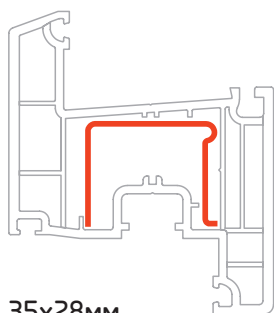

35x28мм

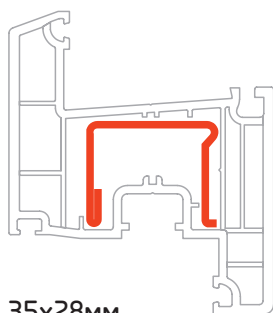
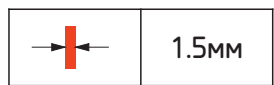

35x28мм

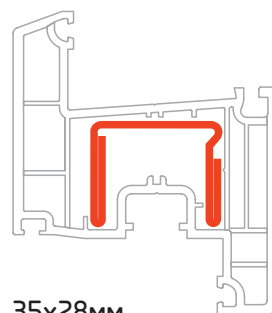
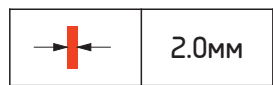

35x28мм

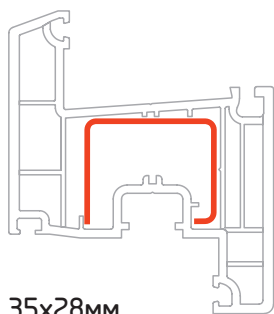
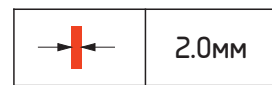

35x28мм

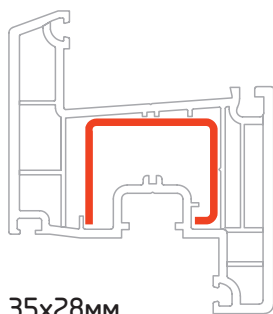
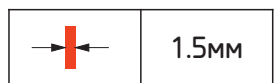

35x28мм

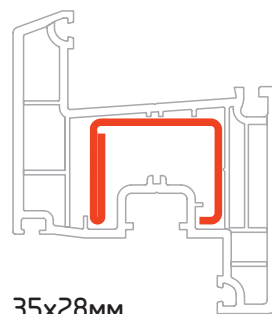
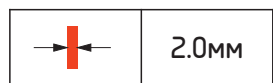

35x28мм

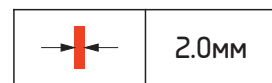

M 1:2

# Штапики

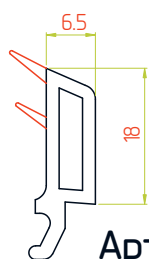
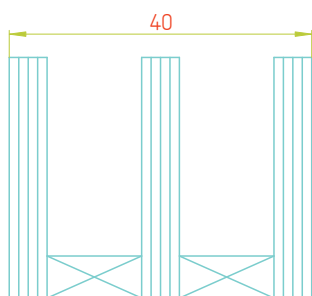

Арт.№2982

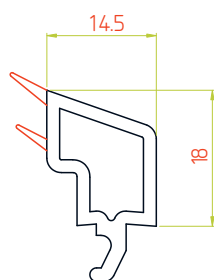
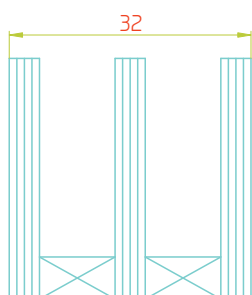

Арт.№2981

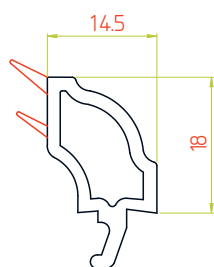

Арт.№3124

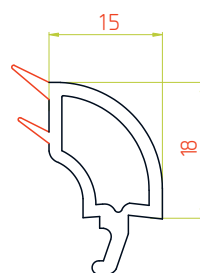

Арт.№3358

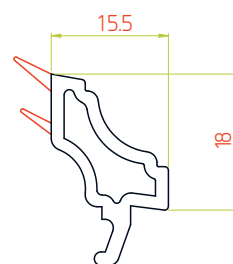

Арт.№3123

## Уплотнители



Арт.№3022002



Арт.№5050002

М 1:1

# Подставочный профиль / Арт.№561013

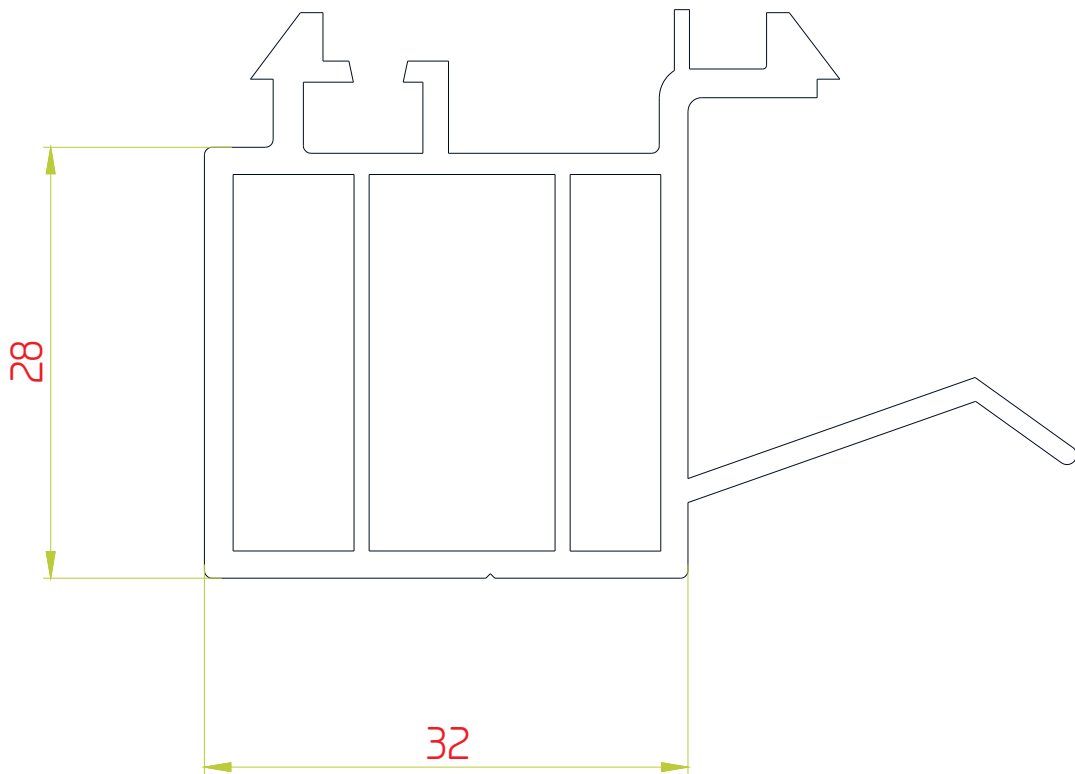

M 2:1

# Сборочный узел

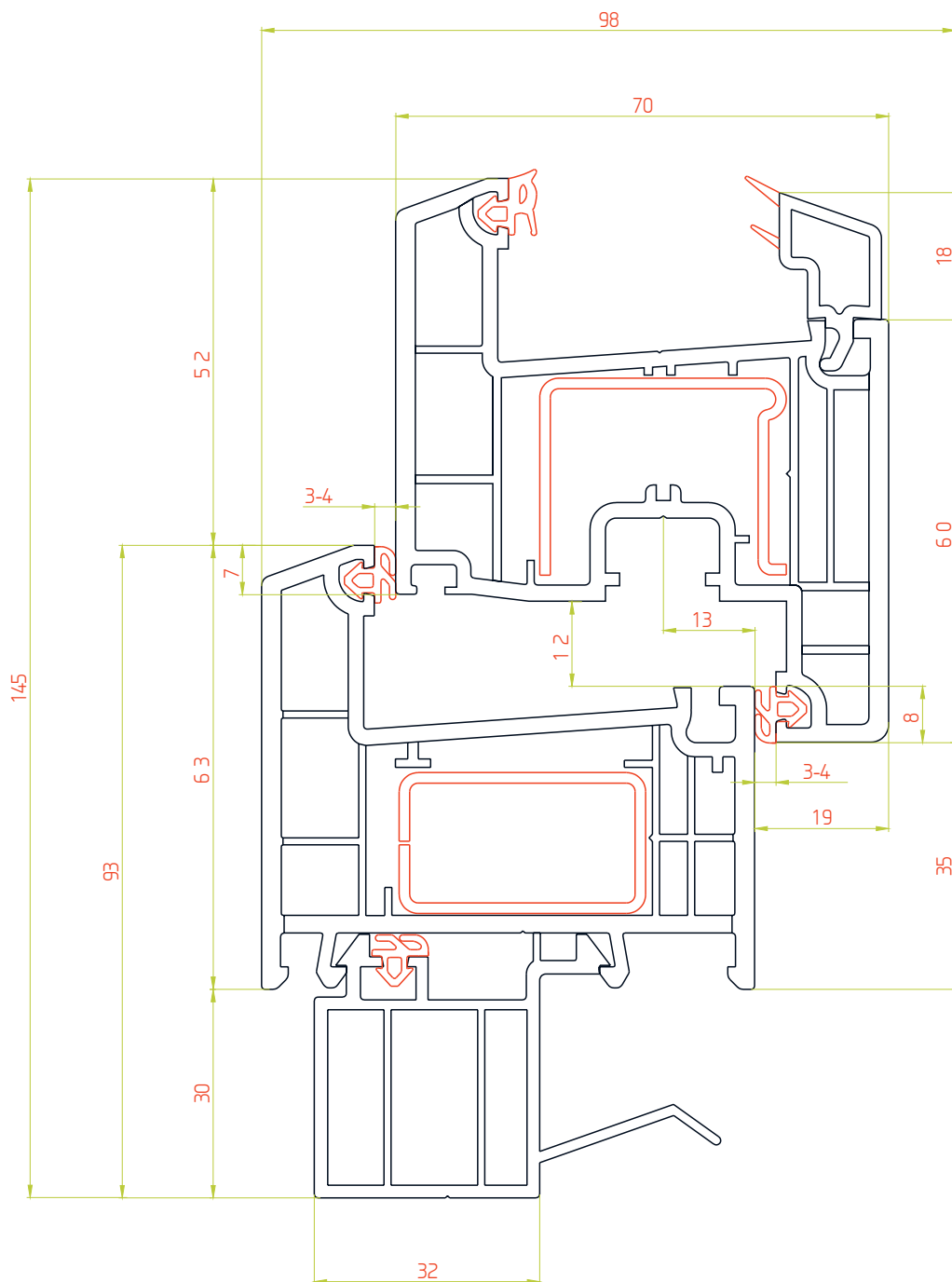

M 1:1





# Сборочный узел

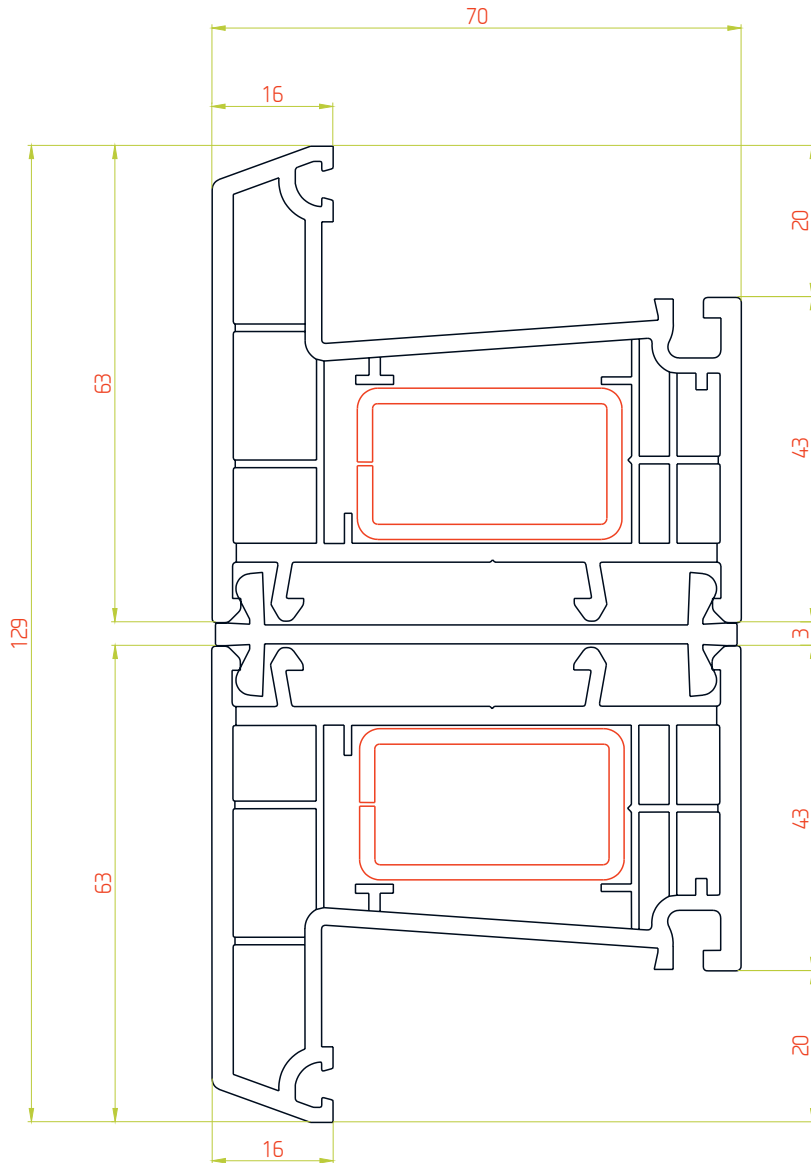

М 1:1

# Сборочный узел

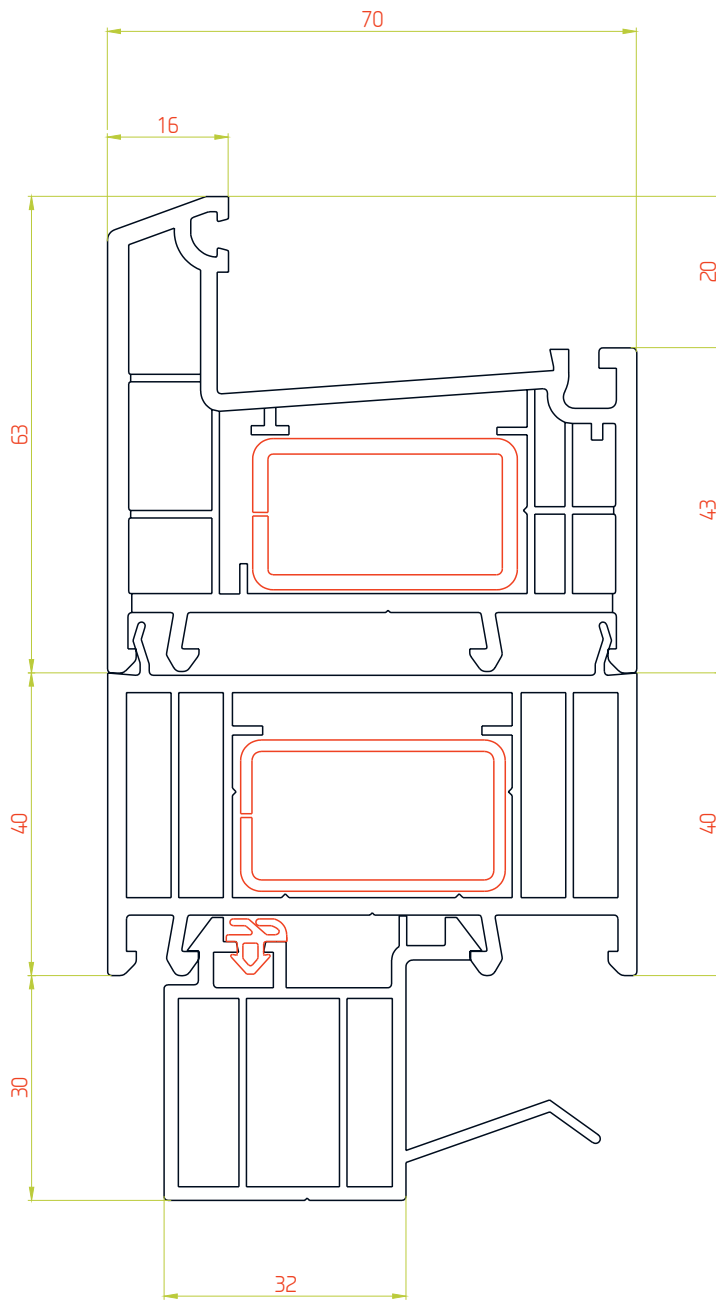

М 1:1

# Сборочный узел

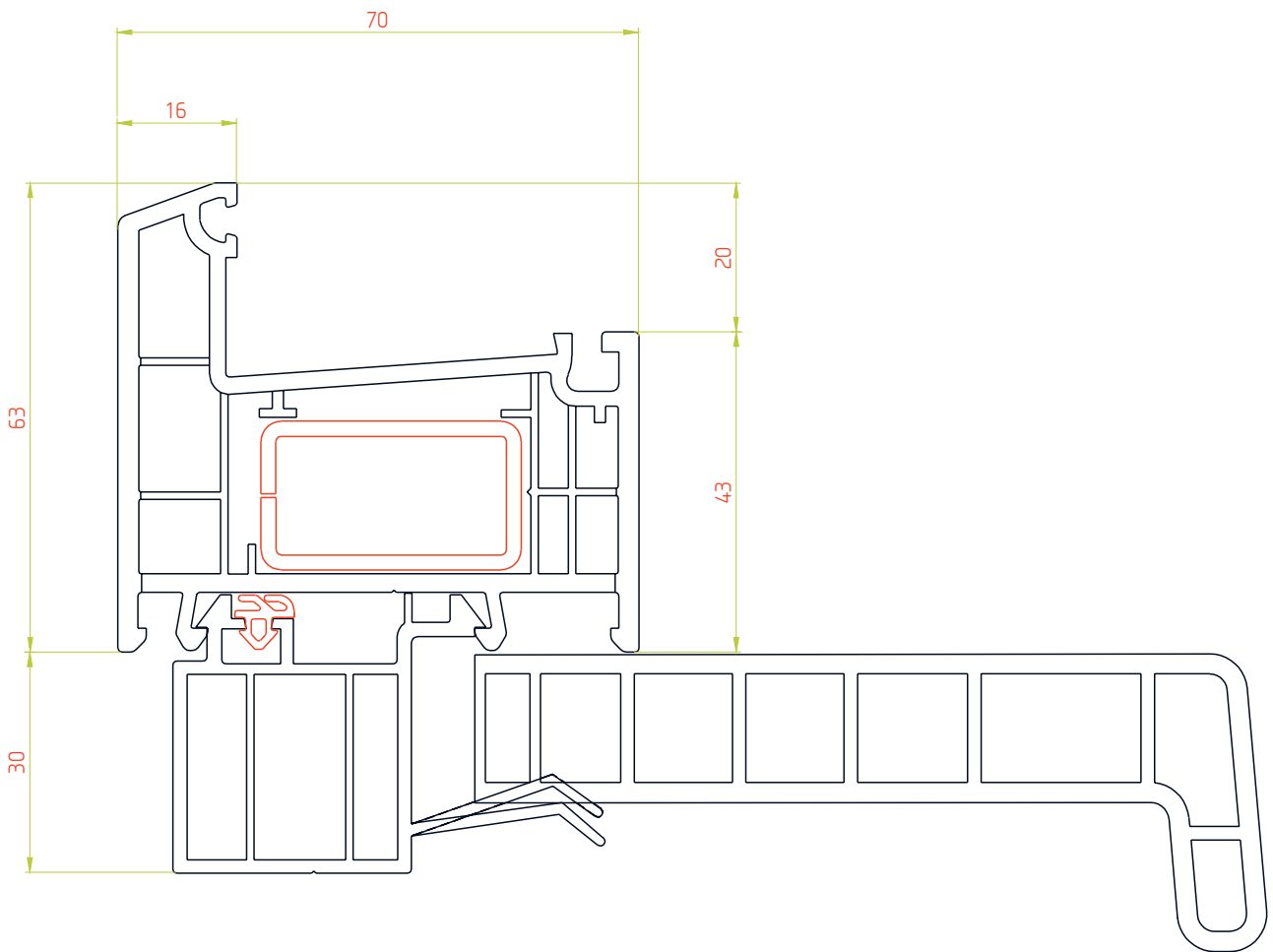

М 1:1