

ПРОФИЛЬНАЯ СИСТЕМА LITE'60

ТЕХНИЧЕСКАЯ ИНФОРМАЦИЯ
ОПИСАНИЕ ПРОФИЛЕЙ

Профильные системы "МЕЛКЕ" изготавливаются методом коэкструзии с использованием вторичного сырья во внутреннем слое, который может отличаться от стандартного белого цвета внешнего слоя

Рама 60мм / Арт.№3442

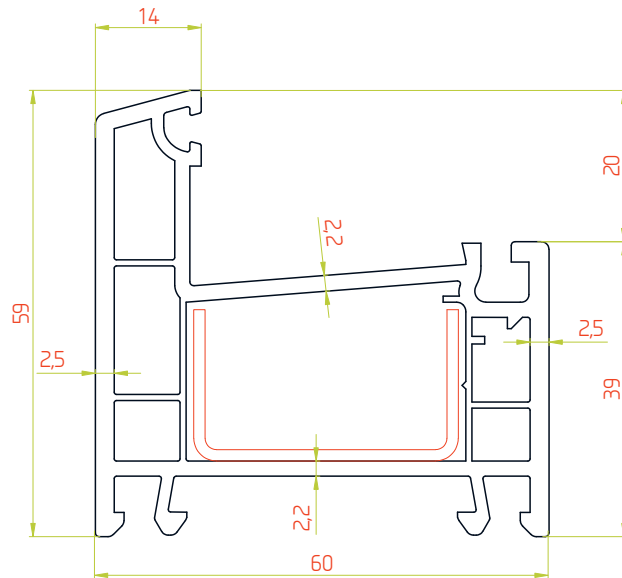

M 1:1

Армирование

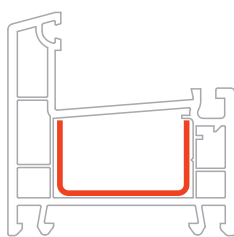

35x20мм

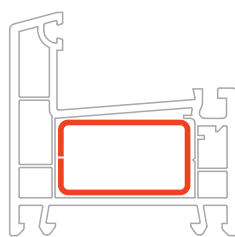
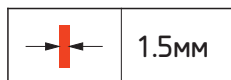

35x20мм

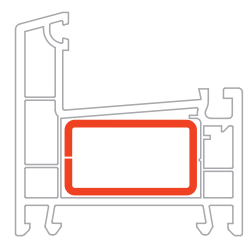
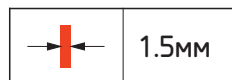

35x20мм

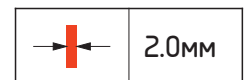

M 1:2

Импост 60мм / Арт.№3106

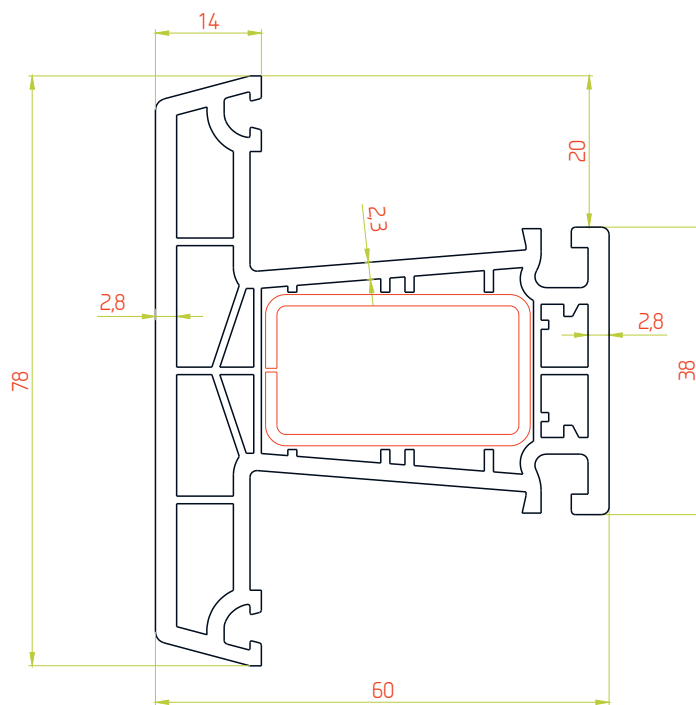

М 1:1

Армирование

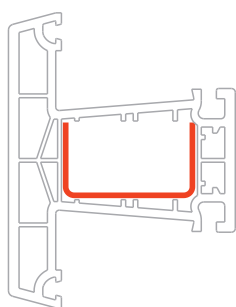

35x20мм

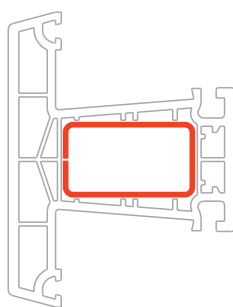
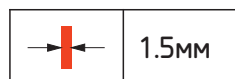

35x20мм

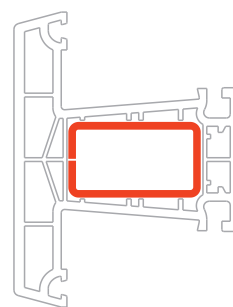
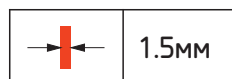

35x20мм

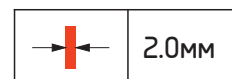

М 1:2

Створка 60мм / Арт.№3443

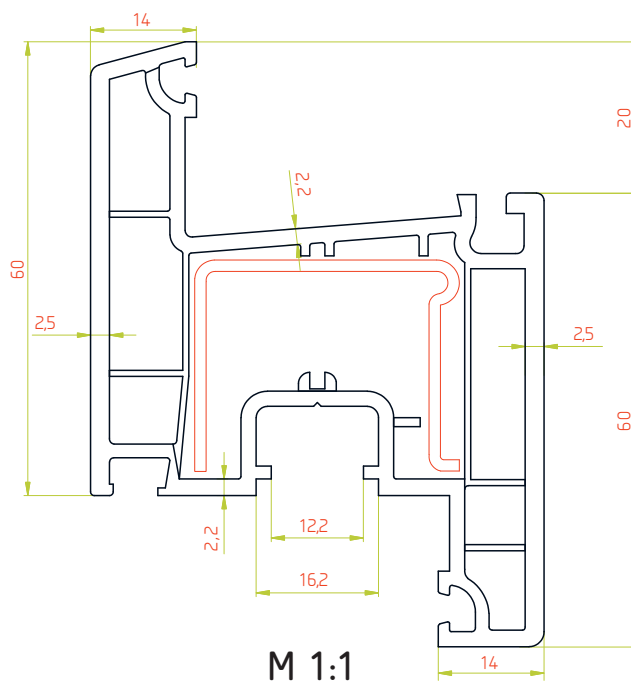

Армирование

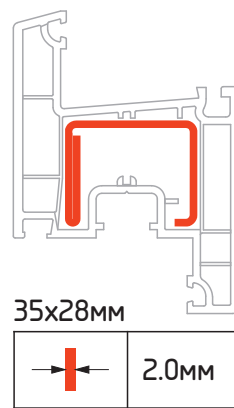
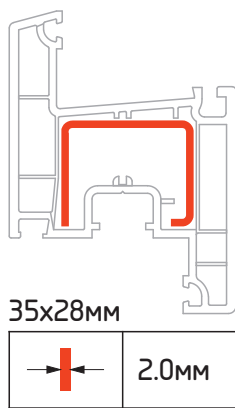
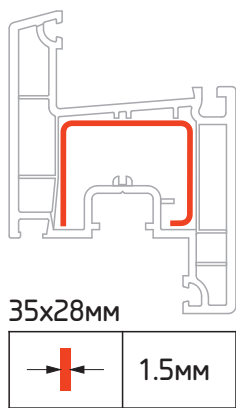
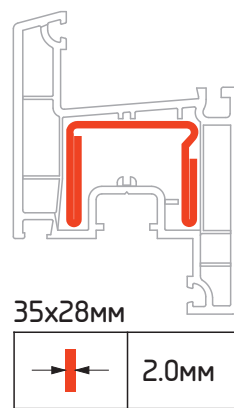
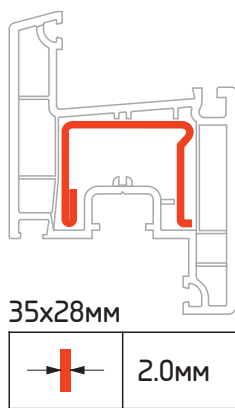
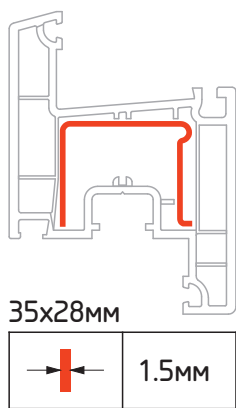

M 1:2

Штапики

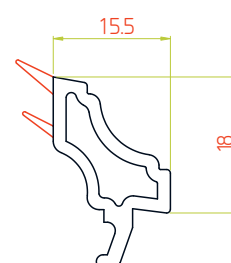
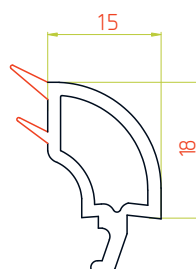
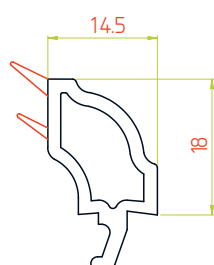
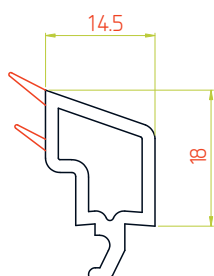
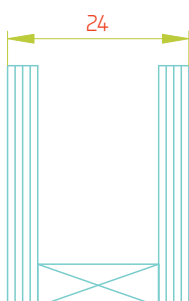
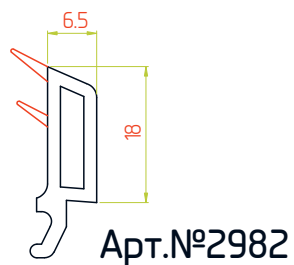
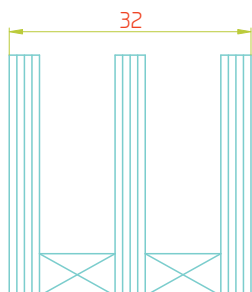

Арт.№2981

Арт.№3124

Арт.№3358

Арт.№3123

Уплотнители



Арт.№3022002



Арт.№5050002

М 1:1

Подставочный профиль / Арт.№561013

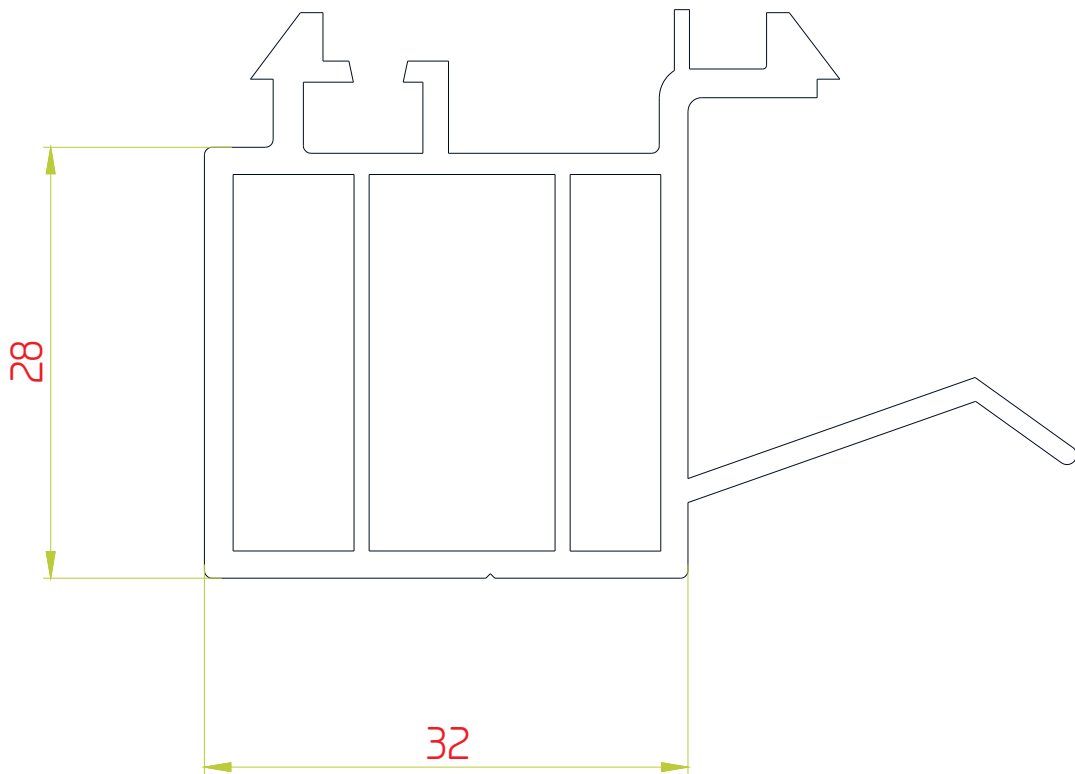

M 2:1

Сборочный узел

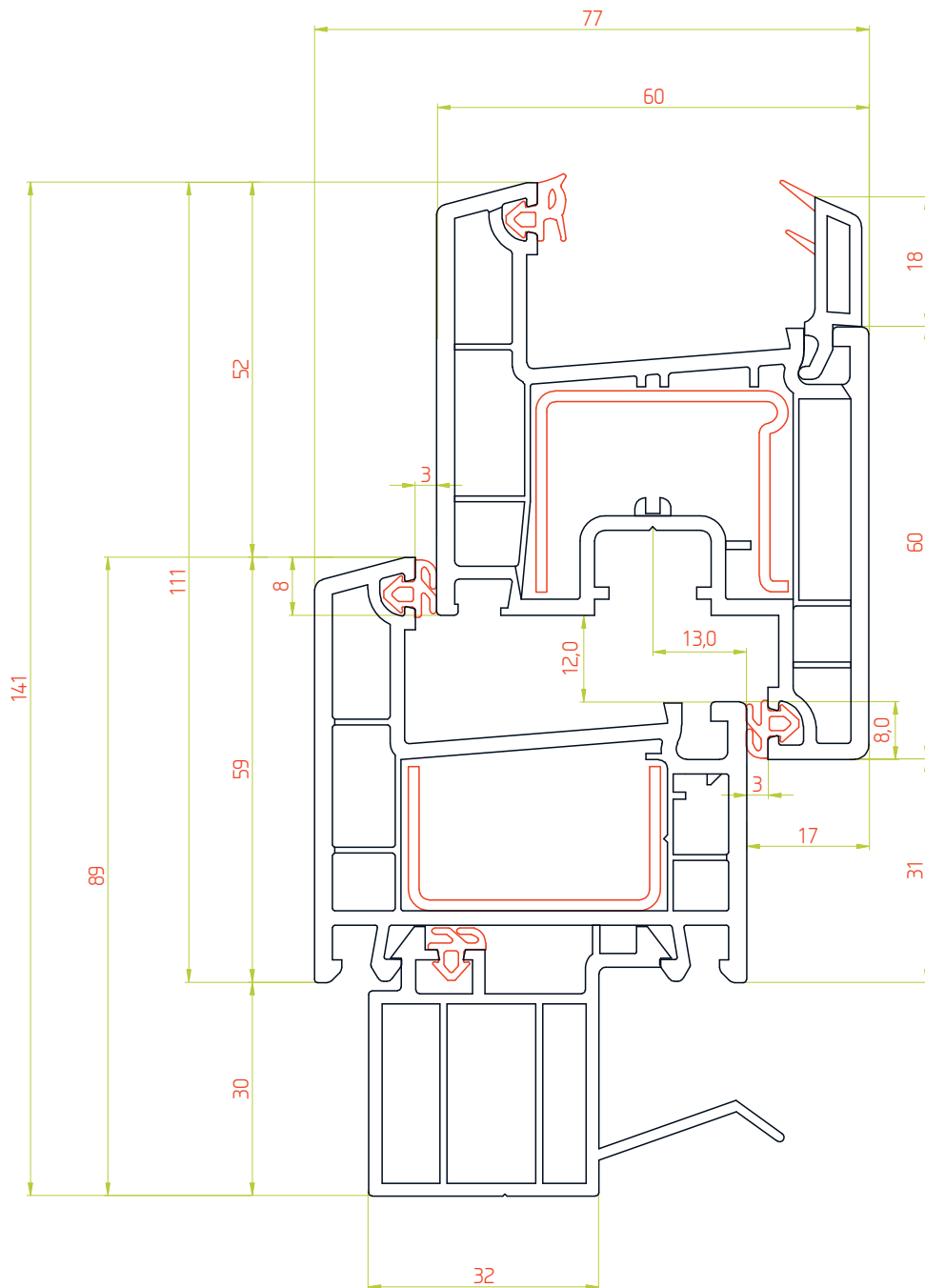

М 1:1